

HAMMERHEAD TOWER CRANE

**Specifications:**

- ▶ Max jib length: 262.4 ft
- ▶ Capacity at max length: 5,070 lbs
- ▶ Max capacity: 44,090 lbs

WORKS FOR YOU.™

KEY

Zeichenerklärung · Légende · Leyenda · Legenda



Hoisting · Heben · Levage · Elevación · Sollevamento



Trolleying · Katzfahren · Distribution · Distribución · Traslazione carrello



Slewing · Schwenken · Orientation · Orientació · Rotazione



Travelling · Schienenfahren · Translation · Traslación · Traslazione



Directive on noise level · Richtlinie für den Schall-Leistungspegel · Directive sur le niveau acoustique · Directiva sobre el nivel acustico · Direttiva sul livello acustico



Consult us · Auf Anfrage · Nous consulter · Consultarnos · Consultateci



Power requirements · Geforderte Stromstärke · Puissance totale nécessaire · Potencia necesaria · Potenza totale richiesta



Power supply · Stromversorgung · Alimentation · Alimentación · Alimentazione



In service · In Betrieb · En service · En servicio · In servizio



Out of service · Außer Betrieb · Hors service · Fuera de servicio · Fuori servizio



Max. under hook height · Höchste Hakenhöhe · Hauteur maxi. sous crochet · Maxima altura bajo gancho · Altezza max. sotto gancio



Without load, without ballast, max. jib and max. height · Ohne Last und Ballast, mit Maximalausleger und Maximalhöhe · A vide, sans lest, avec flèche et hauteur maximum · Sin carga, sin lastre, con pluma y altura máxima · A vuoto, senza zavorra, braccio max., altezza max.



Counterweight · Gegengewicht · Lest de contre-flèche · Lastre de contra flecha · Zavorra controbraccio

C25

FEM 1004 Out of service wind condition · FEM 1004 Windverhältnisse im Außerbetriebszustand · FEM 1004 Conditions de vent hors service · FEM 1004 Condiciones de viento fuera de servicio · FEM 1004 Condizioni del vento in fuori servizio

CONTENTS

SK 415-20

Inhalt · Contenu · Contenido · Indice

Page · Seite · Page · Pàgina · Pagina:

Load Diagram · Lastkurven · Courbes de charges · Curvas de cargas · Diagramma di portata	4
Tower · Turm · Tour · Torre · Torre	6
Other configurations · Aufstellmöglichkeiten · Autres Implantations	
Otras Implantaciones · Altre Installazioni	7
Mechanisms · Antriebe · Mécanismes · Mecanismos · Meccanismi	8
Transportation · Transport · Transportation · Transportation · Trasporto	10

LOAD DIAGRAM

Lastkurven · Courbes de charges · Curvas de cargas · Diagramma di portata

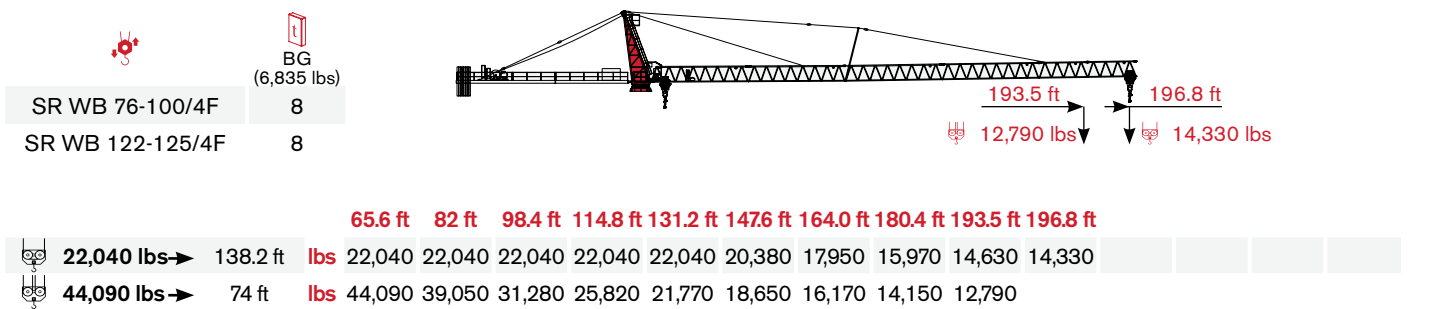
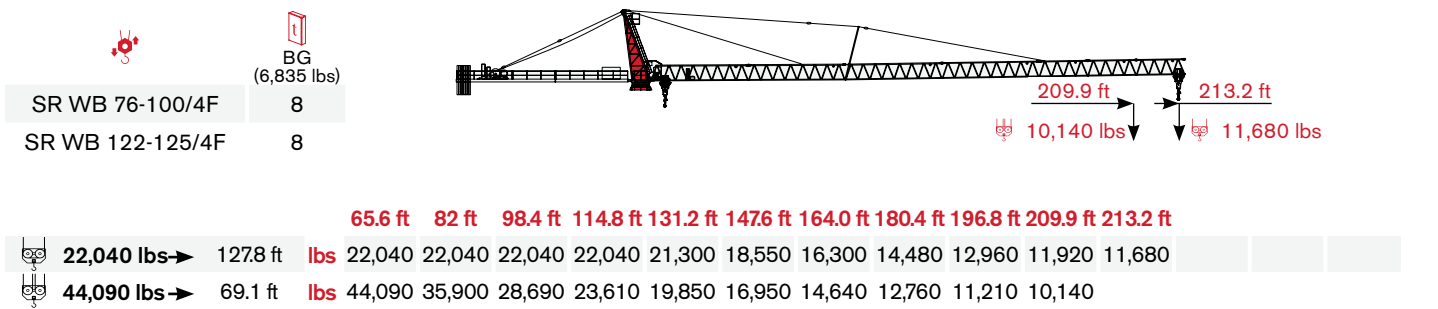
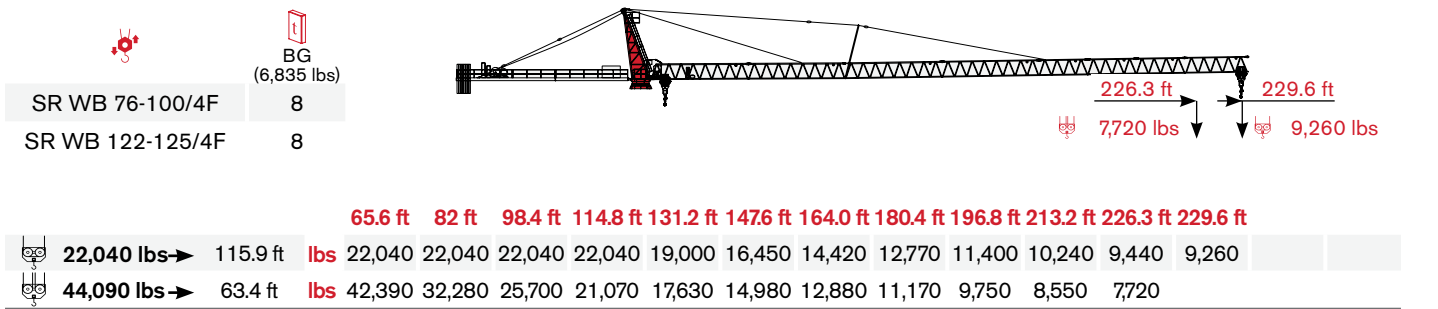
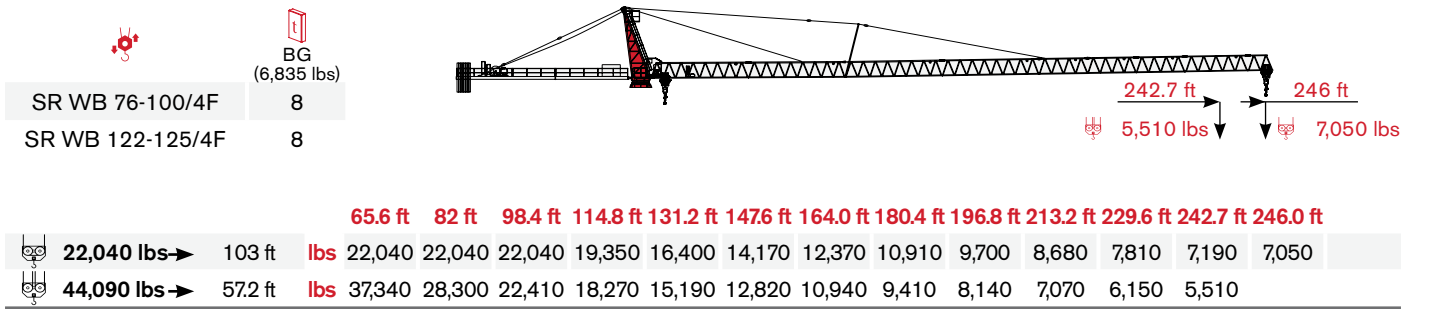
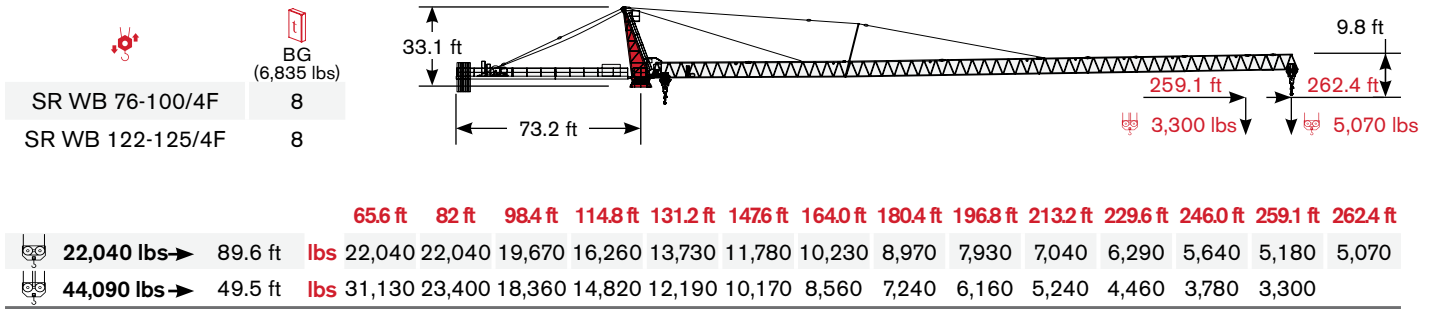

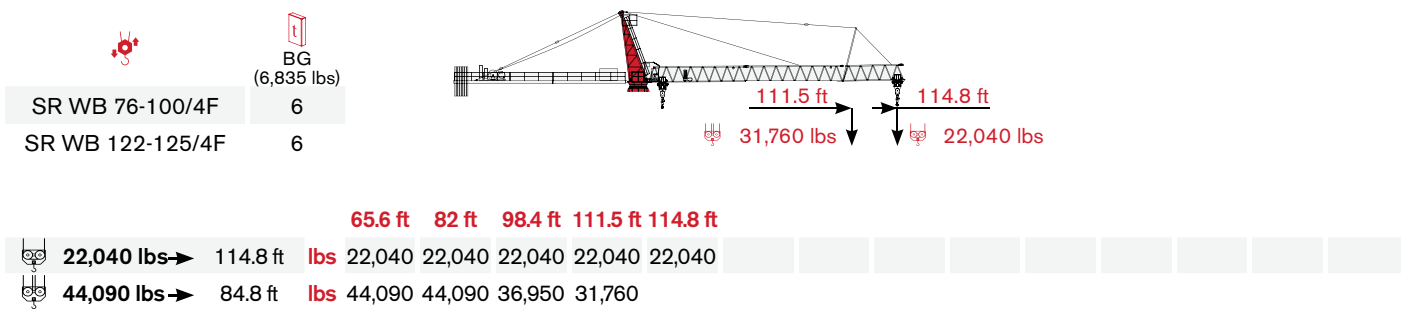
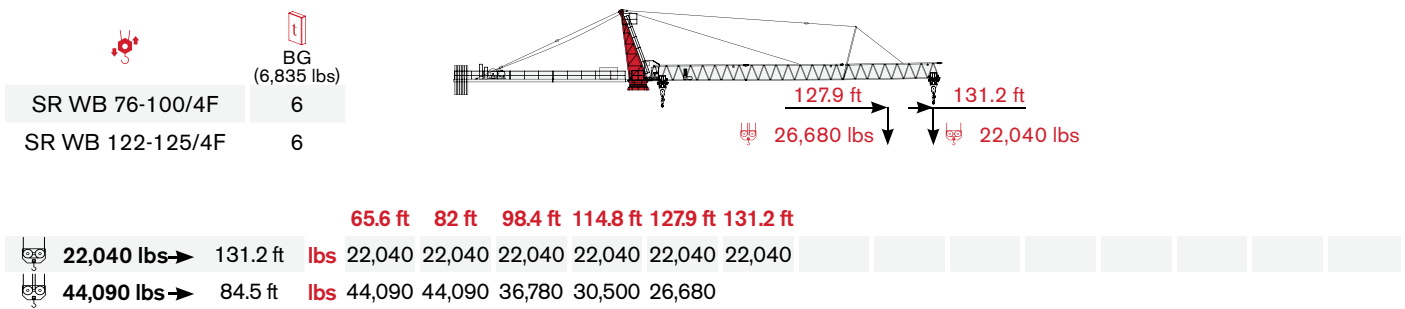
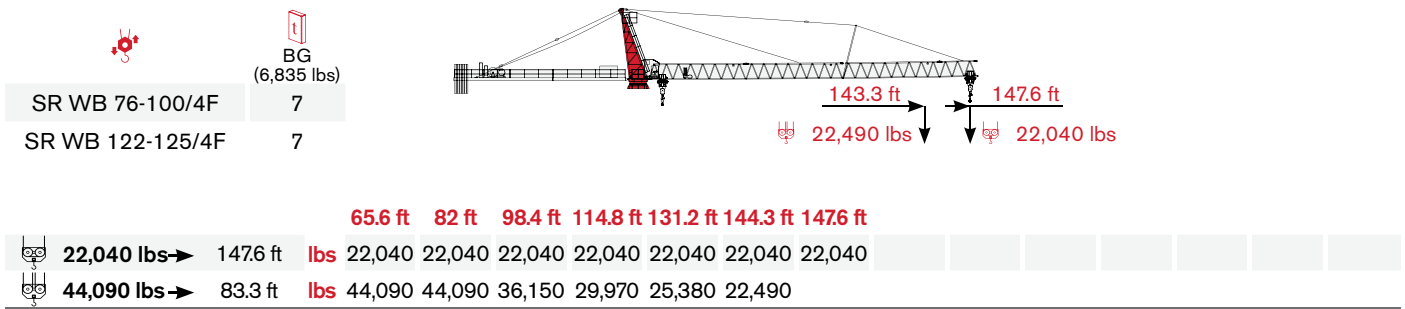
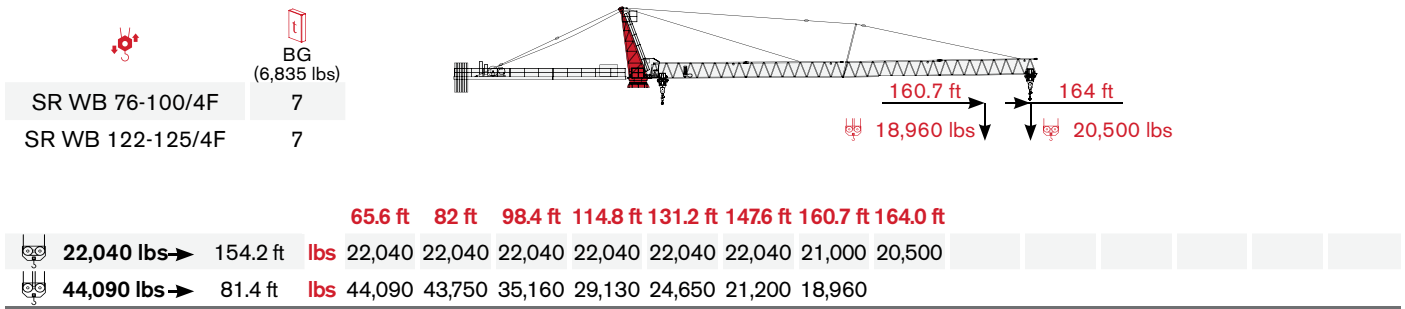
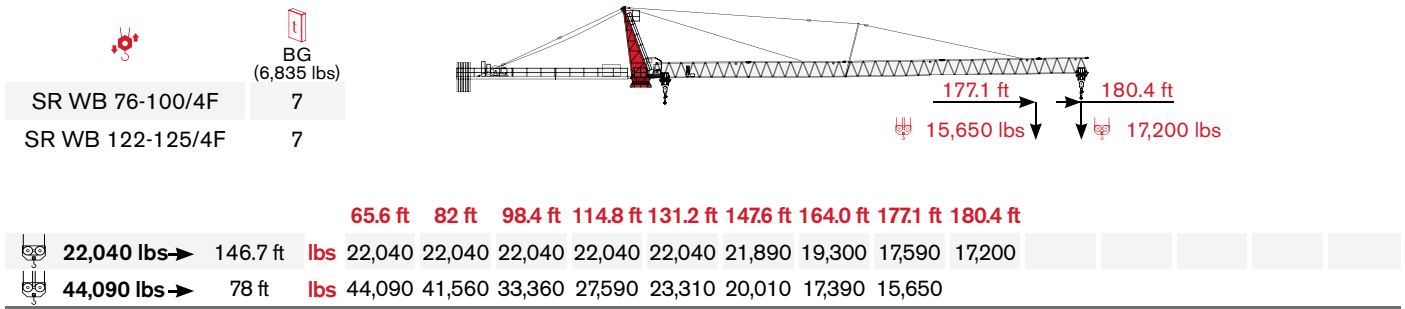

TOWER

Turn · Tour · Torre · Torre

Standard Configurations · Standardkonfiguration · Standard Implantations · Implantaciones Standard · Installazioni Standard

Basement: A

	●	◊
R1	-2655 kN	-2755 kN
R2	1992 kN	2186 kN
	890 kN	

Basement: E

	●	◊
R1	-1121 kN	-1099 kN
R2	0 kN	-51 kN
	978 kN	

Basement: F

	●	◊
R1	1099 kN	-1113 kN
R2	0 kN	-18 kN
	978 kN	

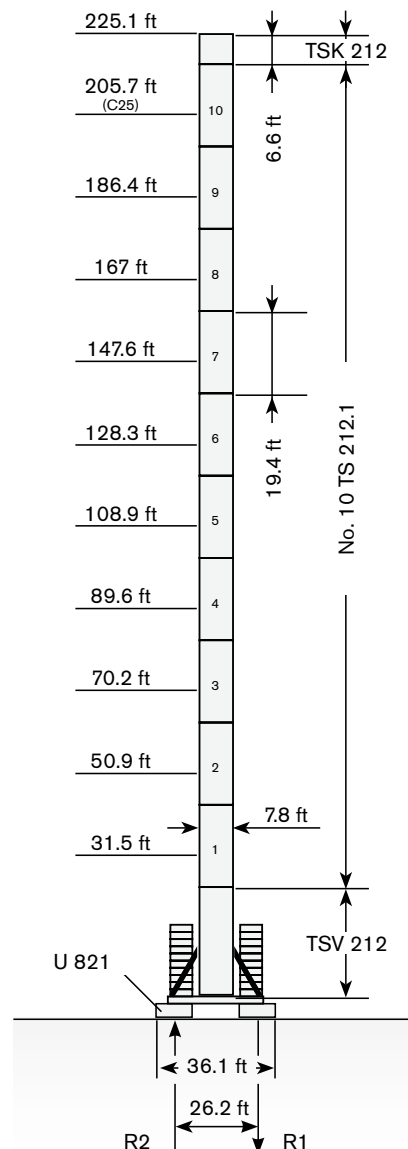
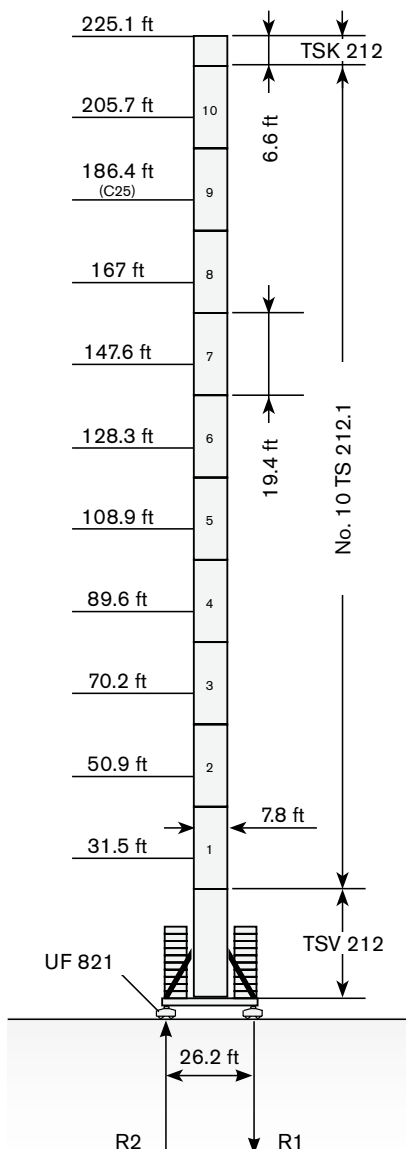
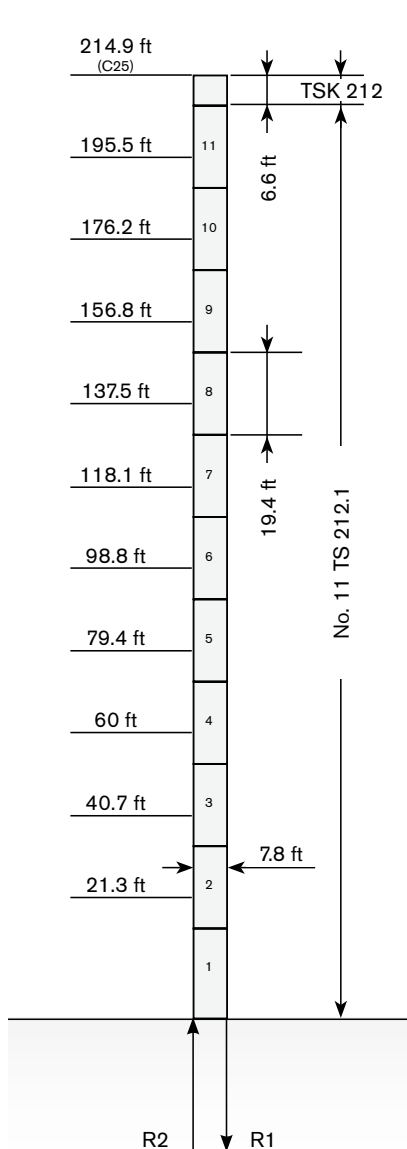

Max. under hook height · Höchste Hakenhöhe · Hauteur maxi. sous crochet · Maxima altura bajo gancho · Altezza max. sotto ganccio

Different heights and tower combinations are available; please consult us · Andere Höhen und Turmkombinationen auf Anfrage · Différentes hauteurs et combinaisons de tour sont disponibles; nous consulter · Hay diferentes alturas y combinaciones de torre disponibles. Consulté-nos · Altezze diverse e combinazioni di torre sono disponibili; consultateci



Other configurations · Aufstellmöglichkeiten · Autres Implantations · Otras Implantaciones · Altre Installazioni

Bottom climbing crane · Kletterkran im Gebäude · Télescopage sur dalles · Telescopage grúa trepadora · Gru climbing

Crane tied to the structure · Geankerter Kran · Grue ancrée · Grúa anclada · Gru ancorata

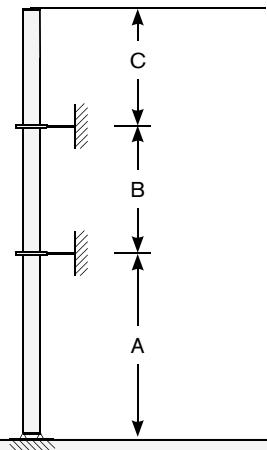
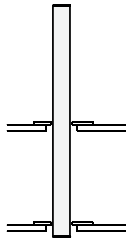

Consult us · Auf Anfrage · Nous consulter · Consultarnos · Consultateci

	min	max
A	68.5 ft	168.3 ft
B	48.4 ft	117.8 ft
C	165.5 ft	

MECHANISMS







Antriebe · Mécanismes · Mecanismos · Meccanismi

Power supply · Stromversorgung ·

Alimentation · Suministro eléctrico · Alimentazione

			
	SR WB 76-100/4F	200 kVA	440V - 480V - 60Hz / 3 ph
	SR WB 122-125/4F	245 kVA	440V - 480V - 60Hz / 3 ph



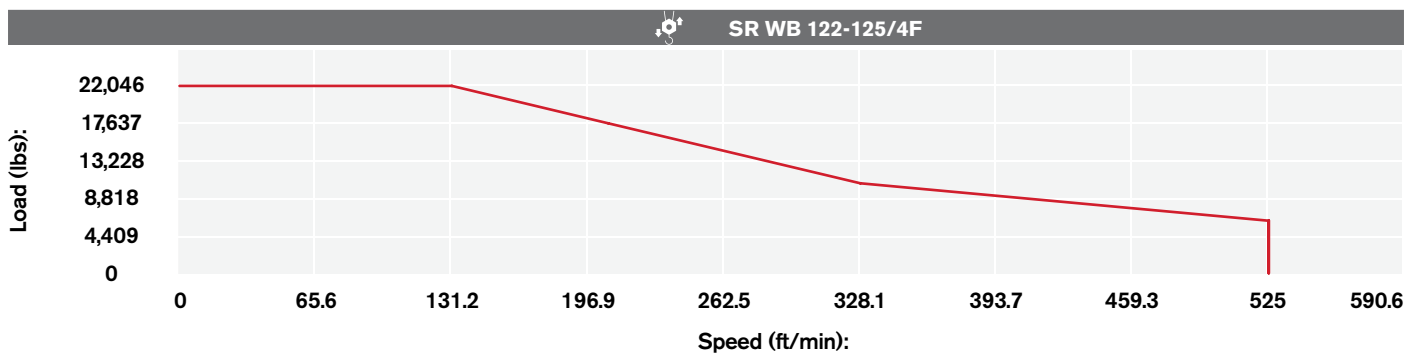
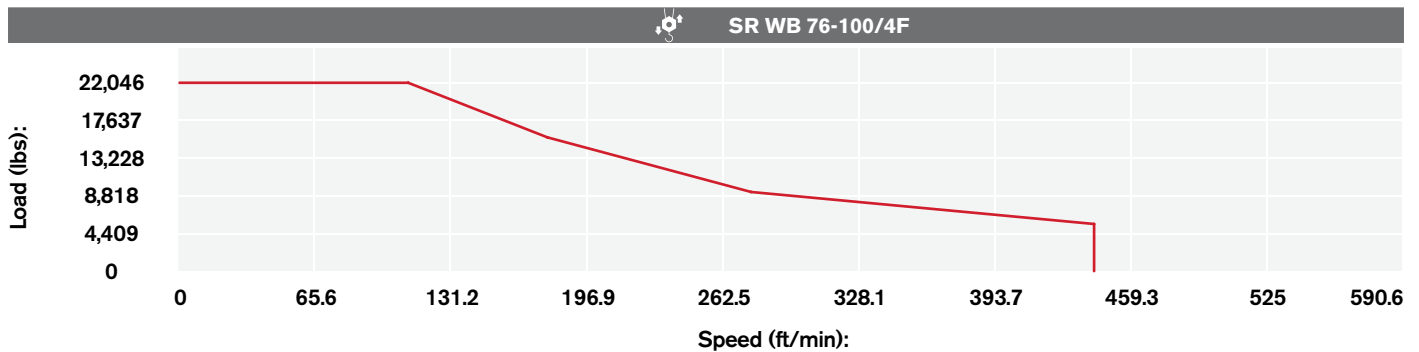

Hoisting · Heben · Levage · Elevación · Sollevamento

			lbs	ft/min	kW	
	SR WB 76-100/4F		5,512	0 → 440	76	1,700 ft
			9,259	0 → 275		
			15,653	0 → 177		
			22,046	0 → 110		
			11,023	0 → 220		
			18,519	0 → 138		
			31,306	0 → 89		
			44,092	0 → 55		
	SR WB 122-125/4F		6,173	0 → 525	122	2,400 ft
			10,582	0 → 328.1		
			17,637	0 → 206.7		
			22,046	0 → 131.2		
			12,346	0 → 262.5		
			21,164	0 → 196.9		
35,274			0 → 101.7			
44,092			0 → 65.6			

Hoisting Speed · Heben Geschwindigkeit · Vitesse de Levage · Velocidad de Elevación · Velocità' di Sollevamento



Additional Specifications · Weitere Leistungsdaten · Spécifications additionnelles · Otras prestaciones · Altre movimentazioni

	FU 9-200/4	0 → 252.6 ft/min	1 x 14.2 HP
	K WB 120/4	0 → 0.9 rpm	2 x 11 HP (114.8 ft - 180.5 ft) 3 x 11 HP (196.9 ft - 246.1 ft)
 	SR 10-190/4	0 → 100 ft/min	4 x 11.9 HP

TRANSPORTATION

Transport · Transport · Conducción · Trasporto















Packing list

SK 415-20	DESCRIPTION · BESCHREIBUNG · DESCRIPTION · DESCRIPCIÓN · DESCRIZIONE	LENGTH · LÄNGE · LONGUEUR · LONGITUD · LUNGHEZZA	WIDTH · BREITE · LARGEUR · ANCHURA · LARGHEZZA	HEIGHT · HÖHE · HAUTEUR · ALTURA · ALTEZZA	WEIGHT · GEWICHT · POIDS · PESO · PESO
	U821 Base Cross for TS212 & 212.1 Tower	34.6 ft	9.1 ft	2.8 ft	17,108 lbs
	TSV 212.1 Tower Section for U821 cross	31.2 ft	9.8 ft	10 ft	20,503 lbs
	213.1 Tower Section	19.5 ft	8 ft	8 ft	9,950 lbs
	TSU 213.1 /212.1 Transition Section	19.5 ft	8 ft	8 ft	9,750 lbs
	212.1 Tower Section	19.5 ft	8 ft	8 ft	9,304 lbs
	TSK 212 Tower Section	8 ft	9.8 ft	6.7 ft	6,173 lbs
	Turntable Complete w/cabin and 3 swing motors	17.2 ft	14.2 ft	12.3 ft	27,602 lbs
	Towertop w / catwalk and ladder	27.1 ft	6.6 ft	6.6 ft	9,612 lbs
	WB 76 Machinery Deck w/o wire rope	9.2 ft	8.4 ft	5.6 ft	7,120 lbs
	WB 122 Machinery Deck w/o wire rope	9.3 ft	8.8 ft	5.7 ft	9,100 lbs
	WB 76 Counterjib complete less wire rope	69.9 ft	9.2 ft	6.6 ft	26,500 lbs
	WB 122 Counterjib complete less wire rope	69.9 ft	9.2 ft	6.6 ft	28,480 lbs
	Jib Section No. 1 w / Trolley machinery	38.9 ft	6.6 ft	7.2 ft	6,636 lbs
	Jib Section No. 2	40.5 ft	6.6 ft	7.2 ft	5,181 lbs

TRANSPORTATION

SK 415-20

Transport · Transport · Conducción · Trasporto

SK 415-20	DESCRIPTION · BESCHREIBUNG · DESCRIPTION · DESCRIPCIÓN · DESCRIZIONE	LENGTH · LÄNGE · LONGUEUR · LONGITUD · LUNGHEZZA	WIDTH · BREITE · LARGEUR · ANCHURA · LARGHEZZA	HEIGHT · HÖHE · HAUTEUR · ALTURA · ALTEZZA	WEIGHT · GEWICHT · POIDS · PESO · PESO
	Outer Jib Support "A" Frame	21.6 ft	5.4 ft	4.7 ft	661 lbs
	Jib Section No. 3	38.8 ft	6.6 ft	7.6 ft	4,762 lbs
	Jib Section No. 4	18.7 ft	6.6 ft	6.3 ft	2,006 lbs
	Jib Section No. 5	35 ft	6.6 ft	6.9 ft	4,012 lbs
	Jib Section No. 6	35.4 ft	6.6 ft	6.3 ft	2,998 lbs
	Jib Section No. 7	33.5 ft	6.6 ft	6.3 ft	2,161 lbs
	Jib Section No. 8	17.1 ft	6.6 ft	6.2 ft	1,764 lbs
	Jib Section No. 9	18.9 ft	6.6 ft	6.3 ft	1,874 lbs
	Jib Tip Section	4.5 ft	6.7 ft	4.5 ft	860 lbs
	Single (outer) Trolley for 2-Part Line	7.3 ft	5.7 ft	6 ft	1,764 lbs
	Single Load Block for 2-Part Line	2.8 ft	1 ft	4.5 ft	1,190 lbs
	Double Trolley for 4-Part Line	14.7 ft	5.7 ft	6 ft	3,417 lbs
	Dual Load Block for 4-Part Line	5.5 ft	1 ft	4.5 ft	2,403 lbs
	BG Counterweight	14.7 ft	0.5 ft	5.1 ft	6,835 lbs
	TS 212 Foundation anchor	2.0 ft	2.0 ft	3.3 ft	660 lbs

www.terexcranes.com

Effective Date: January 2011.

Product specifications and prices are subject to change without notice or obligation. The photographs and/or drawings in this document are for illustrative purposes only. Refer to the appropriate Operator's Manual for instructions on the proper use of this equipment. Failure to follow the appropriate Operator's Manual when using our equipment or to otherwise act irresponsibly may result in serious injury or death. The only warranty applicable to our equipment is the standard written warranty applicable to the particular product and sale and Terex makes no other warranty, express or implied. Products and services listed may be trademarks, service marks or trade-names of Terex Corporation and/or its subsidiaries in the USA and other countries. All rights are reserved. Terex® is a registered trademark of Terex Corporation in the USA and many other countries.

Gültig ab: Januar 2011.

Produktbeschreibungen und Preise können jederzeit und ohne Verpflichtung zur Ankündigung geändert werden. Die in diesem Dokument enthaltenen Fotos und/oder Zeichnungen dienen rein anschaulichen Zwecken. Anweisungen zur ordnungsgemäßen Verwendung dieser Ausrüstung entnehmen Sie bitte dem zugehörigen Betriebshandbuch. Nichtbefolgung des Betriebshandbuchs bei der Verwendung unserer Produkte oder anderweitig fahrlässiges Verhalten kann zu schwerwiegenden Verletzungen oder Tod führen. Für dieses Produkt wird ausschließlich die entsprechende, schriftlich niedergelegte Standardgarantie gewährt. Terex leistet keinerlei darüber hinaus gehende Garantie, weder ausdrücklich noch stillschweigend. Die Bezeichnungen der aufgeführten Produkte und Leistungen sind gegebenenfalls Marken, Servicemarken oder Handelsnamen der Terex Corporation und/oder ihrer Tochtergesellschaften in den USA und anderen Ländern. Alle Rechte vorbehalten. „TEREX“ ist eine eingetragene Marke der Terex Corporation in den USA und vielen anderen Ländern.

Date d'effet : Janvier 2011.

Les spécifications et prix des produits sont sujets à modification sans avis ou obligation. Les photographies et/ou dessins contenus dans ce document sont uniquement pour illustration. Veuillez vous référer à la notice d'utilisation appropriée pour les instructions quant à l'utilisation correcte de cet équipement. Tout manquement au suivi de la notice d'utilisation appropriée lors de l'utilisation de notre équipement ou tout acte autrement irresponsable peut résulter en blessure corporelle sérieuse ou mortelle. La seule garantie applicable à notre équipement est la garantie standard écrite applicable à un produit et à une vente spécifique. Terex n'offre aucune autre garantie, expresse ou implicite. Les produits et services proposés peuvent être des marques de fabrique, des marques de service ou des appellations commerciales de Terex Corporation et/ou ses filiales aux Etats Unis et dans les autres pays, et tous les droits sont réservés. «TEREX» est une marque déposée de Terex Corporation aux Etats Unis et dans de nombreux autres pays.

Fecha efectiva: Enero 2011.

Los precios y las especificaciones de productos pueden sufrir cambios sin aviso previo u obligación. Las fotografías o dibujos de este documento tienen un fin meramente ilustrativo. Consulte el manual de instrucciones del operador correspondiente para más información sobre el uso correcto de este equipo. El hecho de no respetar el manual del operador correspondiente al utilizar el equipo o actuar de forma irresponsable puede suponer lesiones graves o fatales. La única garantía aplicable a nuestro equipo es la garantía escrita estándar correspondiente a cada producto y venta, y TEREX no amplía dicha garantía de forma expresa o implícita. Los productos y servicios mencionados pueden ser marcas registradas, marcas de servicio o nombres de marca de TEREX Corporation o de sus filiales en Estados Unidos de América y otros países, y se reservan todos los derechos. „TEREX“ es una marca comercial registrada de Terex Corporation en Estados Unidos de América y muchos otros países.

Data di inizio validità: Gennaio 2011.

Ci riserviamo il diritto di modificare le specifiche e i prezzi dei prodotti in ogni momento e senza preavviso. Le fotografie e/o i disegni contenuti in questo documento sono destinati unicamente a scopi illustrativi. Consultare le istruzioni sull'uso corretto di questo macchinario, contenute nell'opportuno Manuale dell'operatore. L'inottemperanza delle istruzioni contenute nel Manuale dell'operatore del macchinario e altri comportamenti irresponsabili possono provocare gravi lesioni, anche mortali. L'unica garanzia applicabile ai nostri macchinari è la garanzia scritta standard applicabile al particolare prodotto e alla particolare vendita; Terex è esonerata dal fornire qualsiasi altra garanzia, esplicita o implicita. I prodotti e servizi elencati possono essere dei marchi di fabbrica, marchi di servizio o nomi commerciali di TEREX Corporation e/o società affiliate negli Stati Uniti d'America e altre nazioni e tutti i diritti sono riservati. „TEREX“ è un marchio registrato di Terex Corporation negli USA e molti altri Paesi.

Copyright 2011 Terex Corporation

Terex Cranes, Global Marketing, Dinglerstraße 24, 66482 Zweibrücken, Germany
Tel. +49 (0) 6332 830, Email: info.cranes@terex.com, www.terexcranes.com

Brochure Reference: TC-DS-IMP-E/F/G/I/S-SK415-20-01/11



WORKS FOR YOU.™